

ELETTRODI CONO Ø 18 con. 10%  
ELECTRODES TAPER Ø 18 con. 10%  
KEGELELEKTRODEN Ø 18 kon. 10%

[mossklad.ru](http://mossklad.ru) +7 495 739 51 02

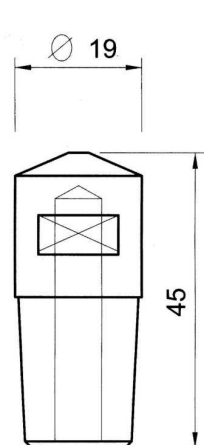

E-73 XEC010

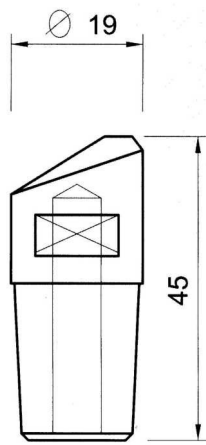

E-74 XEC015

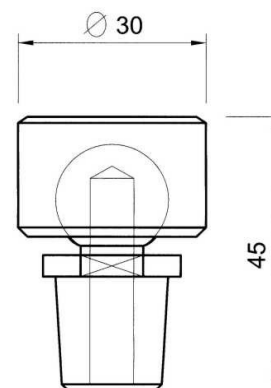

E-78 XEC035

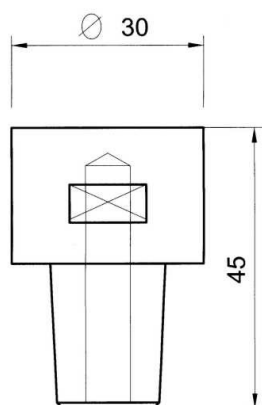

E-59/16 XEP055

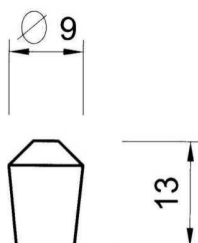

E-89 XEC040

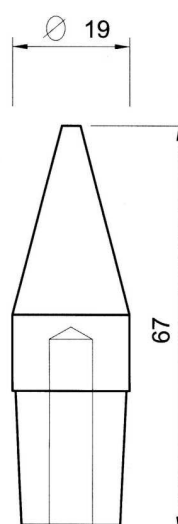

E-350 XES350

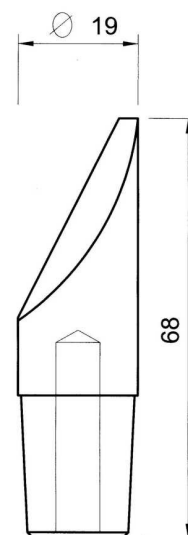

E-351 XES351

XEC010	<b>E-73</b>	Conf. 20 pz	20 pcs pack	20er pckg
XEC015	<b>E-74</b>	Conf. 20 pz	20 pcs pack	20er pckg
XEC020	<b>E-75</b>	cad	each	je
XEC035	<b>E-78</b>	Conf. 5 pz	5 pcs pack	5er pckg
XEP055	<b>E-59/16</b>	Conf. 5 pz	5 pcs pack	5er pckg
XEC040	<b>E-89</b>	Conf. 20 pz	20 pcs pack	20er pckg
XES350	<b>E-350</b>	Conf. 10 pz	10 pcs pack	10er pckg
XES351	<b>E-351</b>	Conf. 10 pz	10 pcs pack	10er pckg

ELETTRODI CONO Ø 18 con. 10%  
ELECTRODES TAPER Ø 18 con. 10%  
KEGELELEKTRODEN Ø 18 kon. 10%

[mossklad.ru](http://mossklad.ru) +7 495 739 51 02

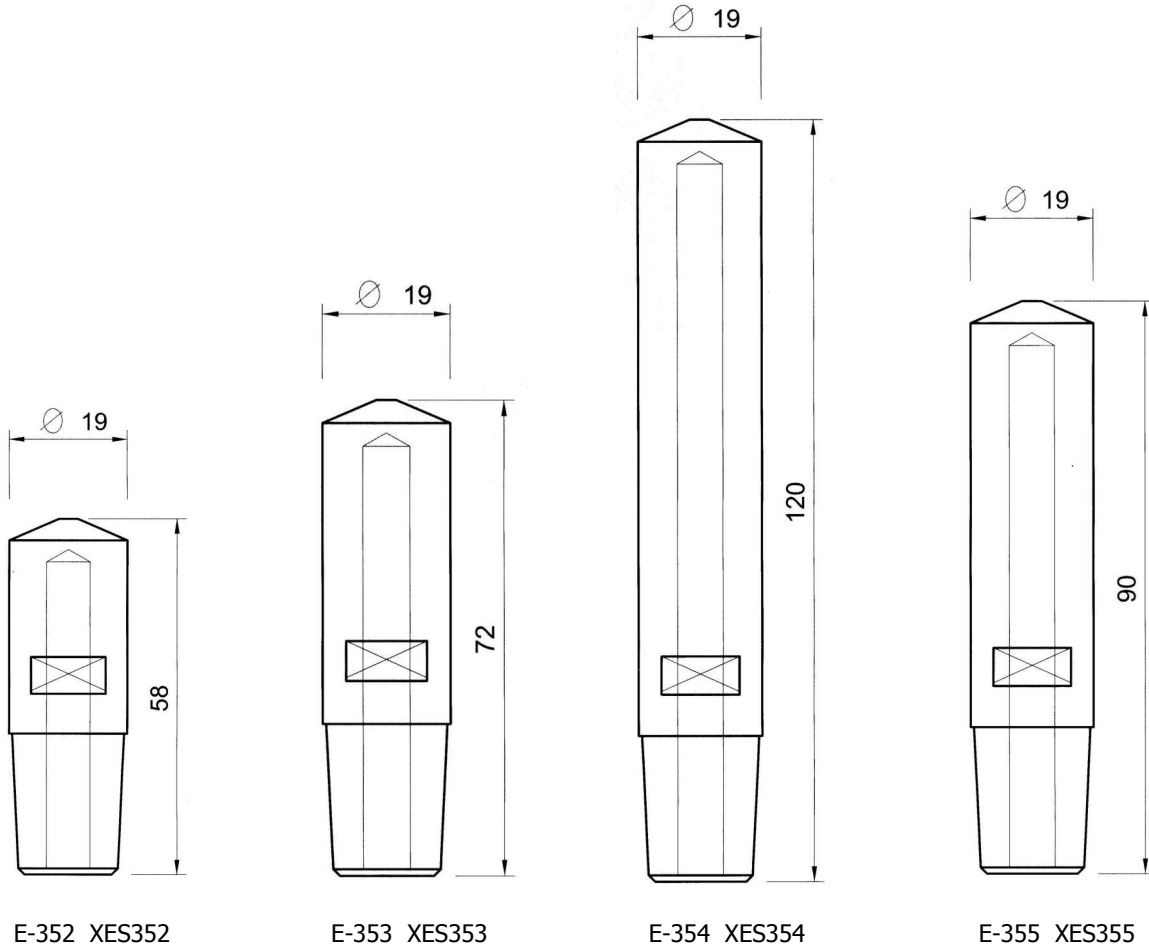

XES352	<b>E-352</b>	Conf. 20 pz	20 pcs pack	20er pkg
XES353	<b>E-353</b>	Conf. 20 pz	20 pcs pack	20er pkg
XES354	<b>E-354</b>	Conf. 10 pz	10 pcs pack	10er pkg
XES355	<b>E-355</b>	Conf. 20 pz	20 pcs pack	20er pkg

ELETTRODI CONO Ø 18 con. 10%  
ELECTRODES TAPER Ø 18 con. 10%  
KEGELELEKTRODEN Ø 18 kon. 10%

[mossklad.ru](http://mossklad.ru) +7 495 739 51 02

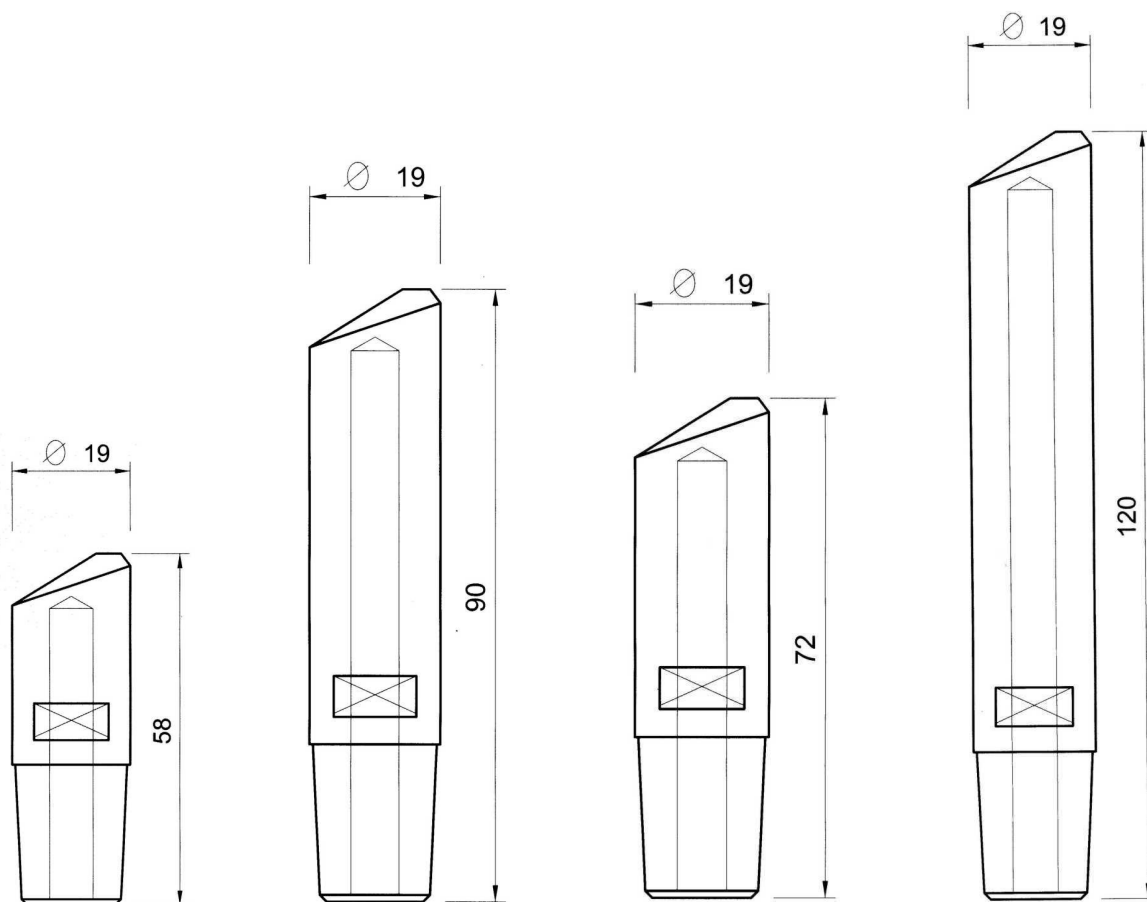

E-356 XES356

E-357 XES357

E-358 XES358

E-359 XES359

XES356	<b>E-356</b>	Conf. 20 pz	20 pcs pack	20er pckg
XES357	<b>E-357</b>	Conf. 20 pz	20 pcs pack	20er pckg
XES358	<b>E-358</b>	Conf. 20 pz	20 pcs pack	20er pckg
XES359	<b>E-359</b>	Conf. 10 pz	10 pcs pack	10er pckg

ELETTRODI CONO Ø 18 con. 10%  
ELECTRODES TAPER Ø 18 con. 10%  
KEGELELEKTRODEN Ø 18 kon. 10%

[mossklad.ru](http://mossklad.ru) +7 495 739 51 02

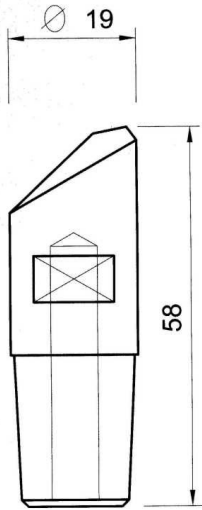

E-360 XES360

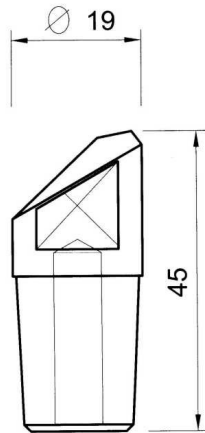

E-361 XES361

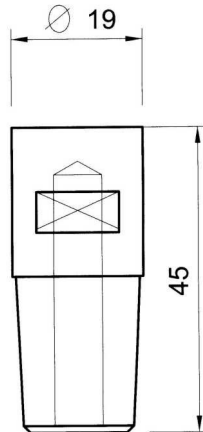

E-362 XES362

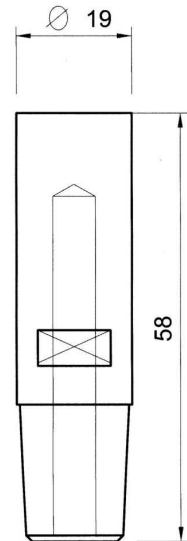

E-363 XES363

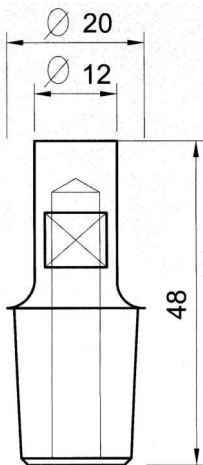

E-364 XES364

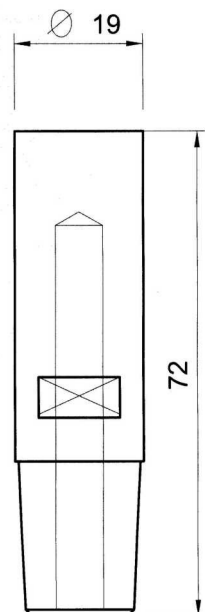

E-365 XES365

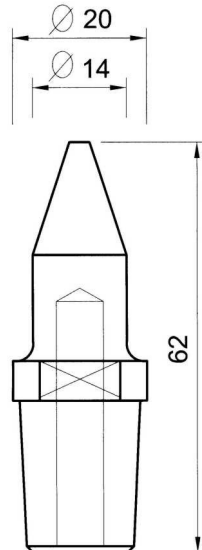

E-366 XES366

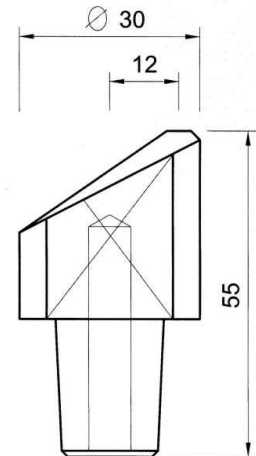

E-367 XES367

XES360	<b>E-360</b>	Conf. 20 pz	20 pcs pack	20er pckg
XES361	<b>E-361</b>	Conf. 20 pz	20 pcs pack	20er pckg
XES362	<b>E-362</b>	Conf. 20 pz	20 pcs pack	20er pckg
XES363	<b>E-363</b>	Conf. 20 pz	20 pcs pack	20er pckg
XES364	<b>E-364</b>	Conf. 20 pz	20 pcs pack	20er pckg
XES365	<b>E-365</b>	Conf. 20 pz	20 pcs pack	20er pckg
XES366	<b>E-366</b>	Conf. 20 pz	20 pcs pack	20er pckg
XES367	<b>E-367</b>	Conf. 5 pz	5 pcs pack	5er pckg

ELETTRODI CONO Ø 18 con. 10%  
ELECTRODES TAPER Ø 18 con. 10%  
KEGELELEKTRODEN Ø 18 kon. 10%

[mossklad.ru](http://mossklad.ru) +7 495 739 51 02

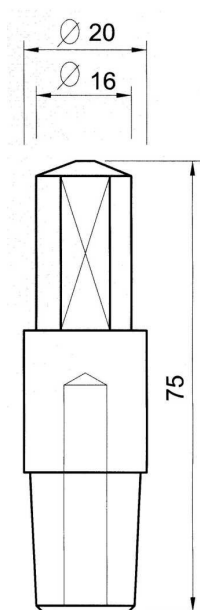

E-368 XES368

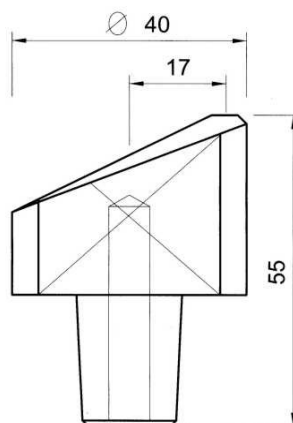

E-369 XES369

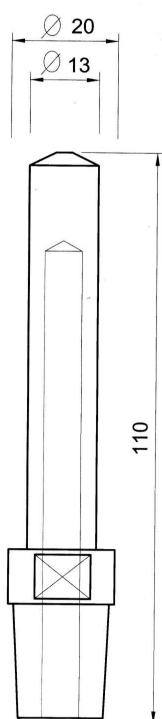

E-370 XES370

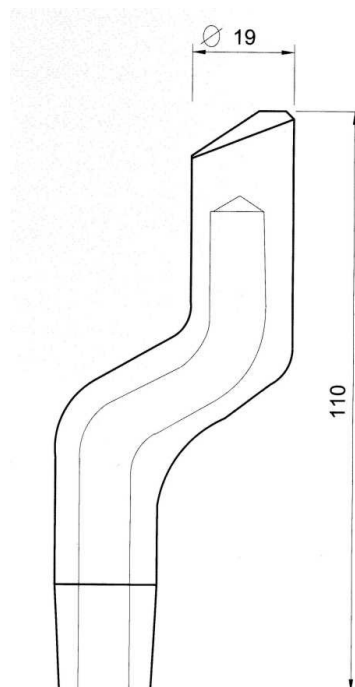

E-371 XES371

XES368	<b>E-368</b>	Conf. 20 pz	20 pcs pack	20er pckg
XES369	<b>E-369</b>	Conf. 5 pz	5 pcs pack	5er pckg
XES370	<b>E-370</b>	Conf. 5 pz	5 pcs pack	5er pckg
XES371	<b>E-371</b>	Conf. 5 pz	5 pcs pack	5er pckg

ELETTRODI CONO  $\varnothing$  18 con. 10%  
ELECTRODES TAPER  $\varnothing$  18 con. 10%  
KEGELELEKTRODEN  $\varnothing$  18 kon. 10%

[mossklad.ru](http://mossklad.ru) +7 495 739 51 02

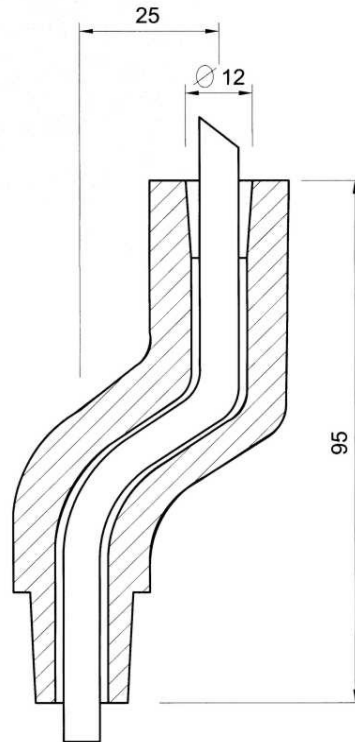

E-380 XES380

XES380	E-380	Cad.	Each	Je
--------	-------	------	------	----

RIDUZIONE CONO 18/12  
TAPER REDUCER 18/12

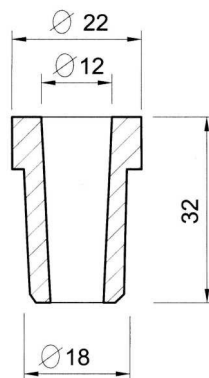

E-90 XEU015

XEU015	E-90	Conf. 5 pz	5 pcs pack	5er pckg
--------	------	------------	------------	----------