

RAS 12.11 / 12.31 / 12.35 / EasyFormer 12.35-2

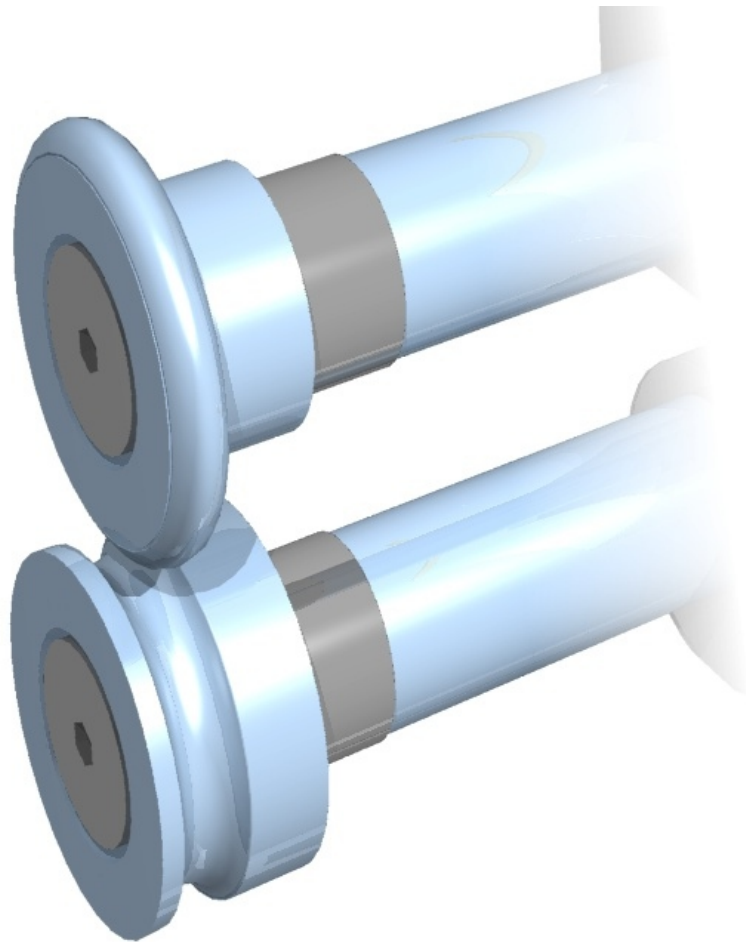

**Für Formwalzen nach DIN 7380 für
Sickenmaschine RAS 12.11 / 12.31 / 12.35 / EasyFormer 12.35-2**

**For forming wheels acc. to DIN 7380 for
Swaging machine RAS 12.11 / 12.31 / 12.35 / EasyFormer 12.35-2**





RAS Reinhardt Maschinenbau GmbH
Richard-Wagner-Str.4 -10
71065 Sindelfingen • Germany
Tel. +49-7031-863-0
Fax +49-7031-863-185

www.RAS-online.de
Info@RAS-online.de

DE - GB / 215891-____
ORIGINAL
5. Oktober 2012

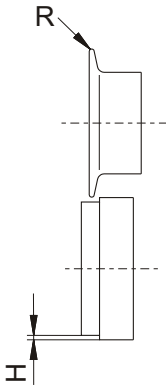
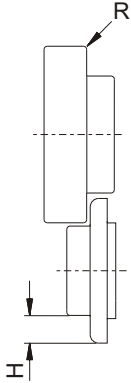
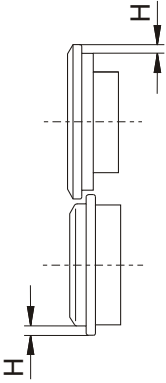

		H	R	Sach-Nr. order-no.
	Bördelwalzen BC Flanging wheels BC	2	1,0	012 022
	Bördelwalzen FL Flanging wheels FL Blechdicke max. 1,0 mm Sheet thickness max. 1,0 mm	10 - 11	1,5	204 316
	Falzwalzen F Seaming wheels F		H	Sach-Nr. order-no.
			4	012 025



	R1	R2	T	Sach-Nr. order-no.
	20	0,6	8	012 028

	B	Sach-Nr. order-no.
	23	012 097
<p>Hierzu geteilter Anschlag erforderlich. Divided stop required.</p>	23	012 114

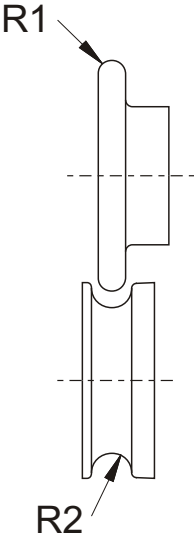

		R1	R2	Sch-Nr. order-no.
	Vornehmwalzen V1 Swaging wheels V1	1,0	2,25	012 182
	Vornehmwalzen V1,5 Swaging wheels V1,5	1,5	3,0	012 000
	Vornehmwalzen V2 Swaging wheels V2	2,0	3,5	012 003
	Vornehmwalzen V2,5 Swaging wheels V2,5	2,5	4,0	012 006
	Vornehmwalzen V3 Swaging wheels V3	3,0	4,5	012 010
	Vornehmwalzen V4 Swaging wheels V4	4,0	5,5	012 013
	Vornehmwalzen V5 Swaging wheels V5	5,0	6,5	012 016
Vornehmwalzen V6 Swaging wheels V6	6,0	7,5	012 019	



<p>R1</p> <p>R2</p>		R1	R2	Sach-Nr. order-no.
	Sickenwalzen S Seaming wheels S	1,0	2,0	012 031
	Sickenwalzen S Seaming wheels S	2,0	3,5	012 034
	Sickenwalzen S Seaming wheels S	3,0	4,5	012 037
	Sickenwalzen S Seaming wheels S	4,0	5,5	012 040
	Sickenwalzen S Seaming wheels S	5,0	6,5	012 043
	Sickenwalzen S Seaming wheels S	6,0	7,5	012 046
	Sickenwalzen S Seaming wheels S	8,0	9,5	012 049
Sickenwalzen S Seaming wheels S	10,0	11,5	012 052	

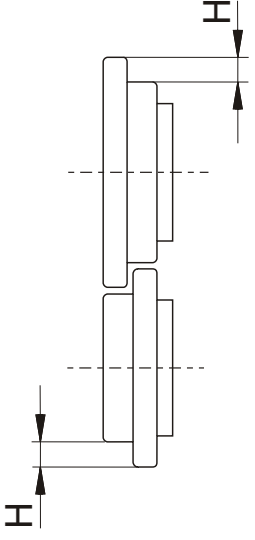
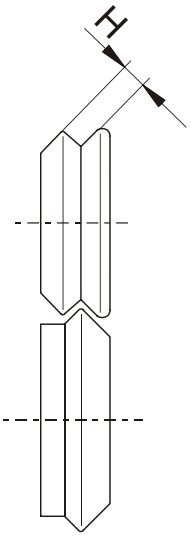

		H	Sach-Nr. order-no.
	Doppelfalzwalzen Double-seaming wheels	6	012 061
	Doppelfalzwalzen Double-seaming wheels	8	012 067
	Doppelfalzwalzen Double-seaming wheels	10	012 073
	Doppelfalzwalzen Double-seaming wheels	12	012 079
 <p>Hierzu geteilter Anschlag erforderlich. Divided stop required.</p>		H	Sach-Nr. order-no.
	Schräge Doppelfalzwalzen Bevel double-seaming wheels	4	012 082
	Schräge Doppelfalzwalzen Bevel double-seaming wheels	6	012 085
	Schräge Doppelfalzwalzen Bevel double-seaming wheels	8	012 088
	Schräge Doppelfalzwalzen Bevel double-seaming wheels	10	012 091
	Schräge Doppelfalzwalzen Bevel double-seaming wheels	12	012 094



<p>Beim Aufbau 1 Passfeder entfernen. Remove one slot stone for assembly.</p>				B	Sach-Nr. order-no.	
	Einziehwalzen Crimping wheels			23	012 173	
<p>Beim Aufbau 1 Passfeder entfernen. Remove one slot stone for assembly.</p>				45	012 172	
	Einziehwalzen Crimping wheels					
<p>Beim Aufbau 1 Passfeder entfernen. Remove one slot stone for assembly.</p>		R1	R2	B	Sach-Nr. order-no.	
	Einziehwalzen mit Anschlagsicke Crimping wheels with stop	3	2	23	212 348	
<p>Blechdicke max. 1,0 mm Sheet thickness max. 1,0 mm</p>						
<p>Beim Aufbau 1 Passfeder entfernen. Remove one slot stone for assembly.</p>		3	2	35	196 951	
	Einziehwalzen mit Anschlagsicke Crimping wheels with stop					
<p>Blechdicke max. 1,0 mm Sheet thickness max. 1,0 mm</p>						
<p>Beim Aufbau 1 Passfeder entfernen. Remove one slot stone for assembly.</p>				H	B	Sach-Nr. order-no.
	Einziehwalzen mit Absetzung Crimping wheels with offset			1,25	36	232 688
<p>Blechdicke max. 0,88 mm Sheet thickness max. 0,88 mm</p>						

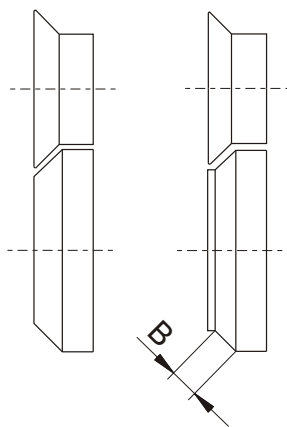
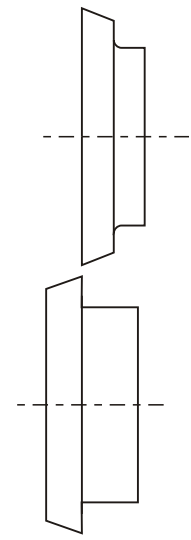

 <p>Hierzu spezielle Anschlagplatten erforderlich. Special stop plate required.</p>		B	Sach-Nr. order-no.
	Schräge Bördelwalzen BD Bevel flanging wheels BD	11	012 099
	Schräge Bördelwalzen BD ohne Bund Bevel flanging wheels BD without collar		012 179
	Spezielle Anschlagplatte (RAS 12.11/12.31) bestehend aus: Special stop plate (RAS 12.11/12.31) consisting of: Anschlagplatte - stop plate 2 Zyl. Schrauben-2 machine screws M6x25		126 375
	Spezielle Anschlagplatte (RAS 12.35/12.35-2) special stop plate (RAS 12.35/12.35-2)		185 491
			Sach-Nr. order-no.
	Schneidwalzen M Cutter wheels M		012 102

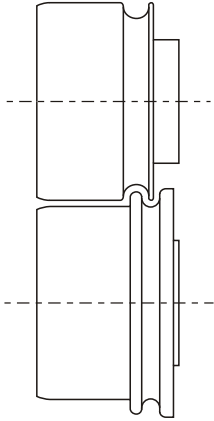
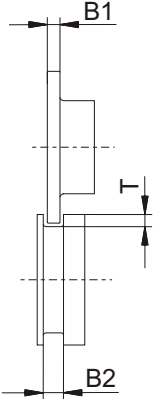
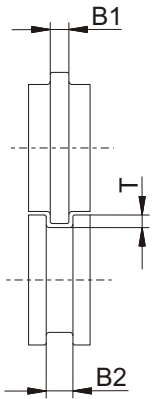
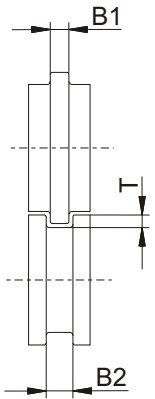
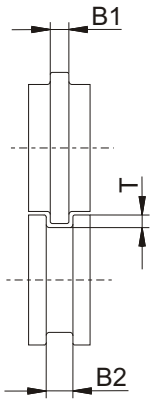

 <p>Hierzu ist große Anschlagplatte 360x300 erforderlich. Large stop plate 360x300 required.</p>	<p>Schraubsickenwalzen Screw-in wheels DBGM 7508145</p>			<p>Sach-Nr. order-no.</p> <p>012 105</p>	
	<p>Blechdicke max. 0,88 mm Sheet thickness max. 0,88 mm</p>				
		B1	B2	T	<p>Sach-Nr. order-no.</p>
	<p>Kastenwalzen Square wheels</p>	5	8	7	012 125
		B1	B2	T	<p>Sach-Nr. order-no.</p>
	<p>Kastenwalzen Square wheels</p>	6	9	6	012 128
		B1	B2	T	<p>Sach-Nr. order-no.</p>
	<p>Kastenwalzen Square wheels</p>	7	10	6	012 131
		B1	B2	T	<p>Sach-Nr. order-no.</p>
	<p>Kastenwalzen Square wheels</p>	9	12	6	012 134

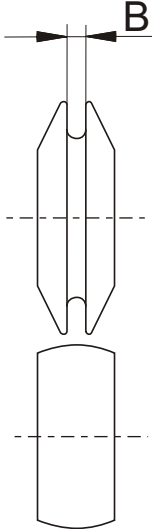

		s	B	Sach-Nr. order-no.
 <p>s = Blechdicke s = sheet thickness</p>	Knierohrwalzen KB Knee pipe wheels KB Blechdicke - sheet thickness	0,63	2,0	012 149
	Knierohrwalzen KB Knee pipe wheels KB Blechdicke - sheet thickness	0,75	2,4	012 152
	Knierohrwalzen KB Knee pipe wheels KB Blechdicke - sheet thickness	0,88	2,8	012 155
	Knierohrwalzen KB Knee pipe wheels KB Blechdicke - sheet thickness	1,0	3,2	012 157
	Knierohrwalzen KB Knee pipe wheels KB Blechdicke - sheet thickness	1,25	4,0	012 159



		B	h	Sach-Nr. order-no.
<p>Rollen zum Absetzen von Rohrsegmenten für Schweißung. Hierfür große Anschlagplatte 360x300 erforderlich.</p> <p>Set-off wheels for pipe segment welding. Large stop plate 360x300 required.</p>	<p>Absetzwalzen KA für Knierohr-Schweifwalzen Set-off wheels KA for knee pipe-chamfering wheels</p> <p>hierzu / hereto Schweifwalzenpaar pair of chamfering wheels</p>	8	1,0	012 116 012 108
	<p>Absetzwalzen KA für Knierohr-Schweifwalzen Set-off wheels KA for knee pipe-chamfering wheels</p> <p>hierzu / hereto Schweifwalzenpaar pair of chamfering wheels</p>	10	1,25	012 119 012 110
	<p>Absetzwalzen KA für Knierohr-Schweifwalzen Set-off wheels KA for knee pipe-chamfering wheels</p> <p>hierzu / hereto Schweifwalzenpaar Pair of chamfering wheels</p>	12	1,75	012 122 012 112

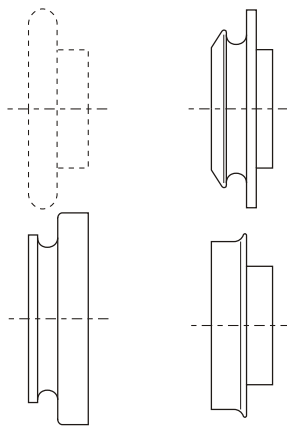

 <p>d = Drahtdurchmesser d = wire diameter</p>	<p>Zulegwalzen ZB Wiring wheels ZB</p>	<p>d</p> <p>4</p>	<p>Sach-Nr. order-no.</p> <p>012 137</p>
	<p>Zulegwalzen ZB Wiring wheels ZB</p>	<p>5</p>	<p>012 141</p>
	<p>Zulegwalzen ZB Wiring wheels ZB</p>	<p>6</p>	<p>012 145</p>